

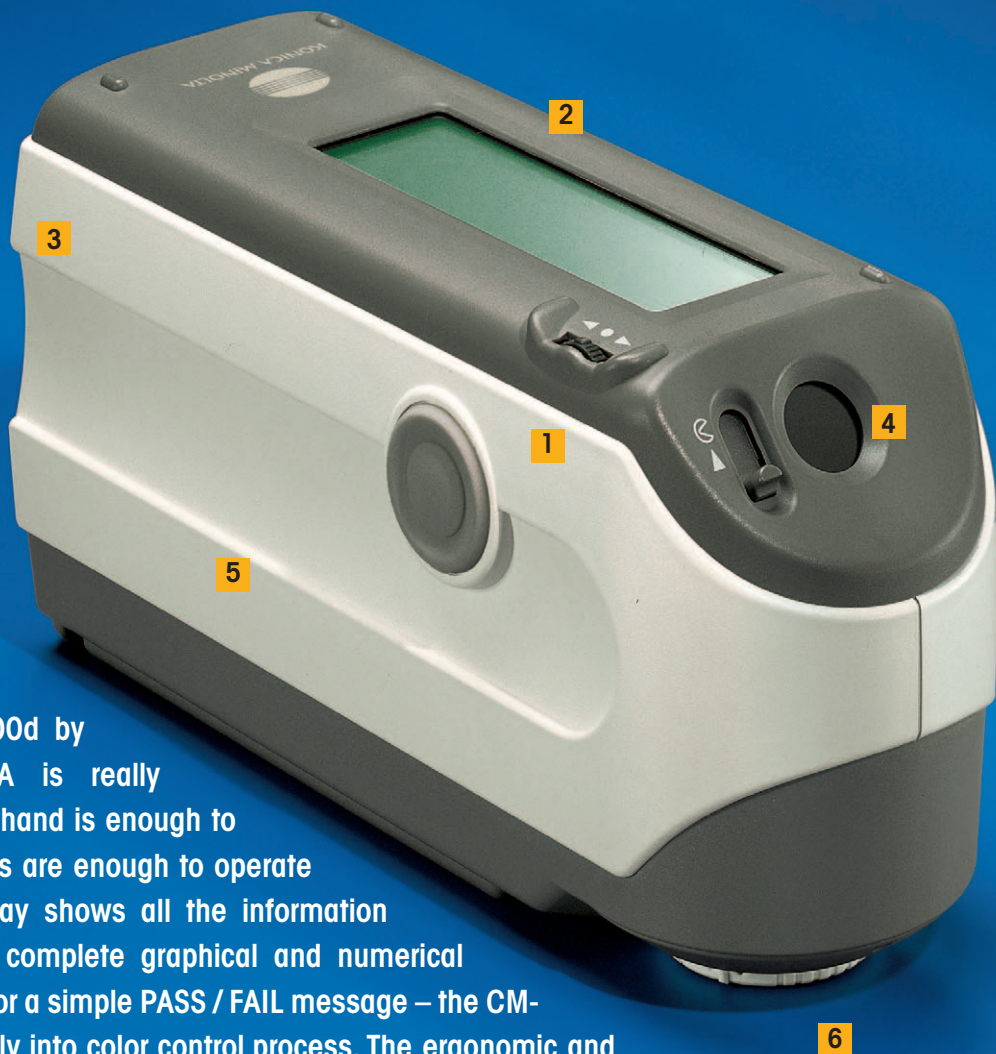

# PRONOUNCING "SPECTROPHOTOMETER" IS THE ONLY COMPLICATED THING ABOUT OUR LATEST PRODUCT.

We don't need to explain to you how important reliability is in color control issues. Whatever your product is, your customers can count on the same color on every item, and so can you.

Today's spectrophotometers all claim to be highly accurate, lightweight and reliable. So what makes the difference? Whoever uses a spectrophotometer wants to use it intuitively and easily.



The new CM-2600d by KONICA MINOLTA is really easy to use. One hand is enough to hold it, two fingers are enough to operate it. The large display shows all the information you need, either complete graphical and numerical color information or a simple PASS / FAIL message – the CM-2600d fits perfectly into color control process. The ergonomic and interactive features encompass all applications in color quality control.

**1 Single handed operation and you're in control of the all new CM-2600d:**

Forget all you have heard about "easy operation" of any portable spectrophotometer so far! The new CM-2600d sets new standards when you look for a simple and fast handling instrument. The exclusive "Navigation wheel" and the measuring button are placed right where your hand fits. The Navigation wheel "guides" you through all the menu options with great ease – Forward, Backward and pressing down like using a PC mouse.



**4 What you see is what you get:**

Sample observation for precise targeting of small specimens has never been as simple as with the CM-2600d. Forget about these fuzzy "stapler" type targeting masks and other unpractical devices. Simply open the sample viewing port and you can exactly see what you're aiming at. Even on very dark colors, the very bright special illumination LED shows you exactly what you'll measure, whether you're using the large or the small aperture mask. Once you have positioned the CM-2600d, just let the lever go and take the measurement.

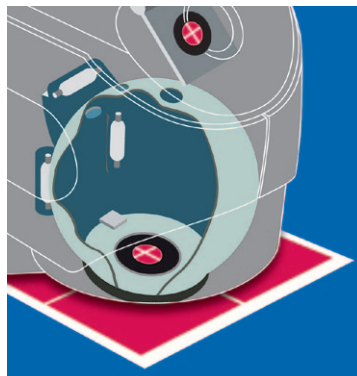

**5 Fits comfortably into your hand :**

Weighing only 670 gr. (without batteries) and combined with its ergonomic design, the CM-2600d is perfectly suited for any application in the laboratory in the field. Taking measurements horizontally or vertically is both easy and fatigue free. The compact size and accessible measurement aperture allows you to measure samples of any shape or size.



**2 Comprehensive and informative color Data Information Display:**

The large Display is your "Information Centre". Displaying data graphically or numerically, it shows you the facts about your colors at a glance. Whether you select simple Pass/Fail indications, colorimetric data with descriptive color difference, or L\*a\*b\* color graph with either box or elliptical tolerances, – you're in control at any time. And also Relativity Gloss Value can be displayed by using Numerical Gloss Control. The internal software contains all necessary colorimetric equations and standard light sources to cover your tasks as well as numerous industry and application specific indices.

The internal software communicates in six languages (English, German, French, Italian, Spanish and Japanese) and thus is prepared for your international color communication network. It even reminds you when it is time for a factory re-calibration to ensure traceability to ISO-9000 recommendations.



Pass / Fail Display Relativity Gloss Value

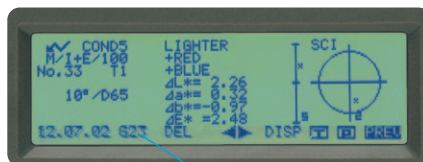

Color graph + data Display Relativity Gloss Value



Simultaneous color difference with wording for SCI and SCE Relativity Gloss Value



Spectral graph Relativity Gloss Value

**6 Two measuring apertures to cover all sample sizes:**

The CM-2600d offers you great flexibility of use with two interchangeable measurement apertures with  $\varnothing$  8 mm (MAV) and –  $\varnothing$  3 mm (SAV). Changing the aperture mask is very easy and quick. The two lens position settings guarantee perfect data correlation with both apertures, – as you can expect from a leading-optical precision manufacturer. These two apertures enable you to measure samples of all size and shapes and avoid taking time consuming average measurements on structured surfaces or faulty results on small samples.



**3 You'll never be out of power**

With the CM-2600d, you have the free choice of three different power sources (batteries, rechargeable batteries or AC power), making your portable instrument ready for action at any time in any place. No need to wait for charging or being out of power at the wrong moment.

# NORTH, EAST, SOUTH, WESTWARD HO! EXPANDING THE BOUNDARIES TO A GLOBAL COLOR DATA COMMUNICATION NETWORK.

In today's global network, customers, manufacturers and numerous suppliers have to work hand in hand when it comes to Total Quality Assurance. Reliable and correlating color data are a real challenge for flawless color communication in the whole manufacturing process, from R&D to Production and Quality Assurance. KONICA MINOLTA, one of the global leading manufacturers of color measuring systems and pioneer in portable spectrophotometers offers you the most extensive and complete range of instruments to meet this challenge.

The new CM-2600d, a highly interactive portable color measuring instrument, fits perfectly into KONICA MINOLTA's broad range of color measuring systems. The perfect inter-instrument agreement with the line of bench-top instruments as well as the commonly shared line of software, create a total solution system, suited for all stages in the manufacturing process throughout all kinds of applications. It is therefore not just a new fine piece of hardware, but also the expansion into a new generation of instrumentation linked with the world of Information Technology.

## The issue: color data communication in a network

When it comes to color data communication within your company or in combination with your customers and suppliers, then the main issue is inter-instrument and inter-model agreement. These two terms describe the level of measurement data agreement between several instruments or the same type and/or several different models. The better this agreement is, the more it is possible to exchange color data within the network for flawless Quality Control. Through accurate design of all optical parts in full accordance with international norms and severe quality control levels, KONICA MINOLTA has earned the highest reputation for best inter-instrument and inter-model agreement levels. So you can choose a bench-top instrument for the laboratory and confidently exchange data with the CM-2600d in the Production and Quality Assurance department.

Network construction for color control either within an organisation or between organisations

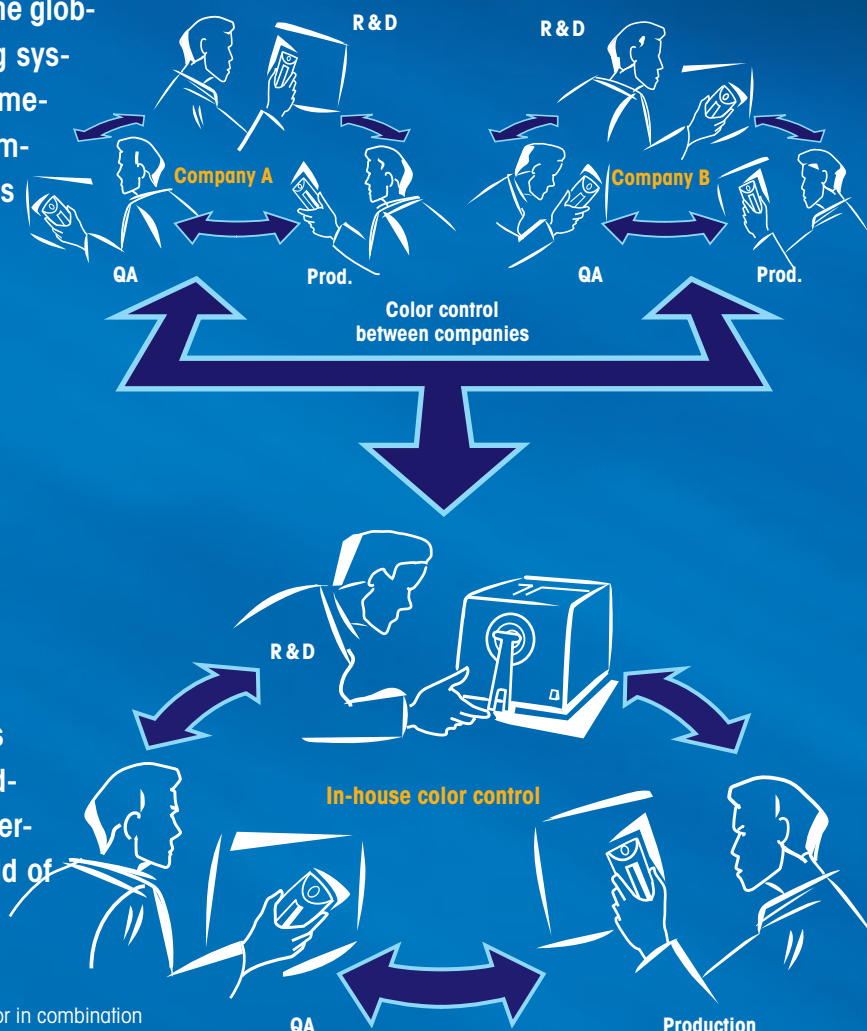

# SpectraMagic™ **NX** (optional)

Supports Windows® Vista/7/8/8.1

SpectraMagic™ **NX** enables you to perform comprehensive color inspection and analysis of incoming raw materials, in process production, and outbound color critical goods and materials in virtually any industry. With SpectraMagic™ **NX** you can insert digital images with measured data. Measure samples in any of 8 universally accepted color spaces. Select from 16 illuminants, and up to 40 indices to determine specific color and appearance properties, such as strength, brightness, haze, yellowness, opacity and strength. You can even configure up to 8 customized color equations. Reports range from simple Pass/Fail to trend charts, histograms, color plots, and spectral graphs. SpectraMagic™ **NX** comes with predefined templates or you can create your own templates. For illustrations and explanations to understanding color and color measurement technology, there is a link to Konica Minolta's well known and respected "Precise Color Communication". Step by step navigation help.

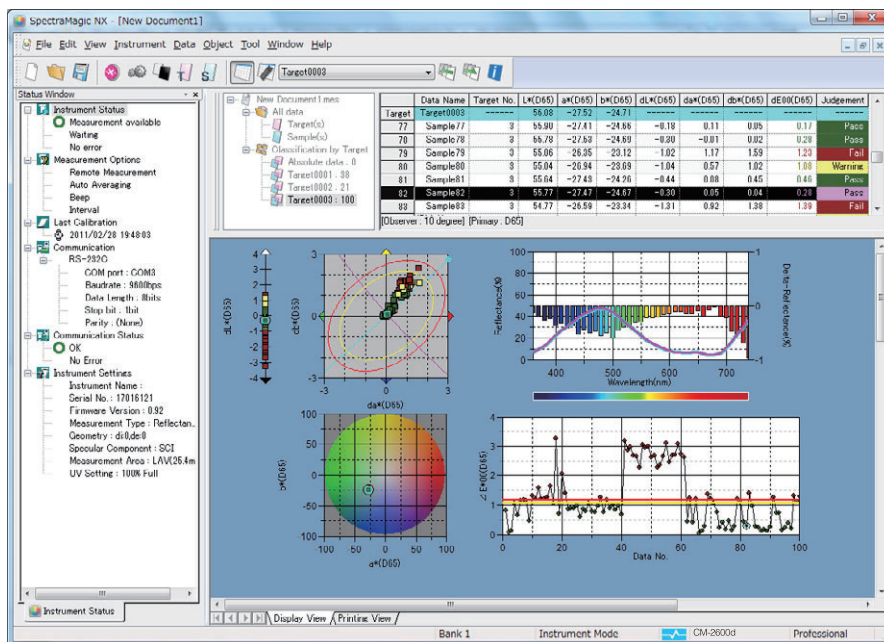

- Windows® is a trademark of Microsoft Corporation in the USA and other countries.

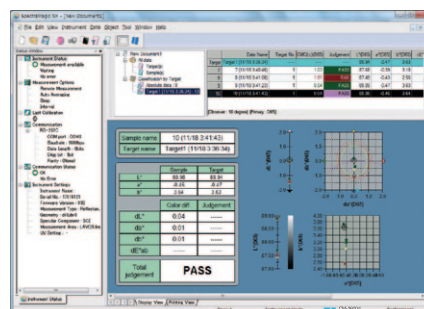
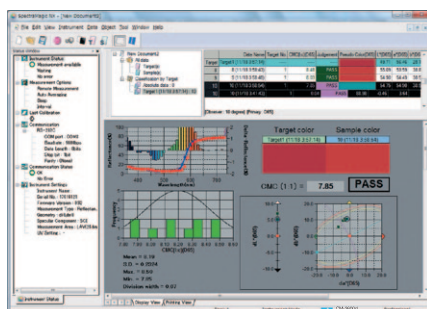

# PEOPLE OFTEN TALK ABOUT "INNER VALUES". HERE THEY CAN FIND LOTS OF THEM.

Isn't it the wish of every user to master highly sophisticated instruments with absolute ease? Or is this a fantasy, which will never come true? Our answer to these questions is the new—portable spectrophotometer, the CM-2600d. It combines very simple, comfortable and intuitive use with KONICA MINOLTA's patented Innovative Optical System to meet the highest expectations for color measurement for Quality Assurance of almost any application.

Initially launched with the bench-top spectrophotometer CM-3600d, this innovative technology includes Numerical Gloss- Control (NGC) and, now available for the first time in a portable instrument, numerical UV-Control (NUVC).

Together with the high energy xenon flash illumination and the high resolution monolithic dual beam monochromator, this technology is free from moving parts and therefore guarantees substantial advantages in ruggedness and reliability.

## World first: Numerical UV-Control

The CM-2600d is the world's first portable instrument to offer the patented numerical UV-Control (NUVC). This innovative technology drastically reduces calibration and measurement procedure time when measuring products treated with optical brighteners such as Textiles, Papers and Detergents. Instead of using the mechanically driven filters of traditional methods, the NUVc technology uses two xenon flashes (one including UV and one excluding UV energy) and special mathematics. Within a few seconds you get both results, with and without UV as well as under different illumination conditions.

UV-calibration procedure requires optional SpectraMagic™ NX software.

## Unequaled: Numerical Gloss Control

Another patented and therefore exclusive – feature is the Numerical Gloss Control (NGC), which, for each measurement, provides simultaneous data with specular component included (SCI) and excluded (SCE). Instead of mechanical moving parts, NGC sequentially fires two xenon flashes, for SCI and SCE. At any time, you can display both measuring results in the display of the CM-2600d. NGC technology has also enable the achievement of Relativity Gloss Value display. The advantages of NGC technology lies in its superior optical results as well as the absence of any moving parts making the CM-2600d rugged enough for portable applications.

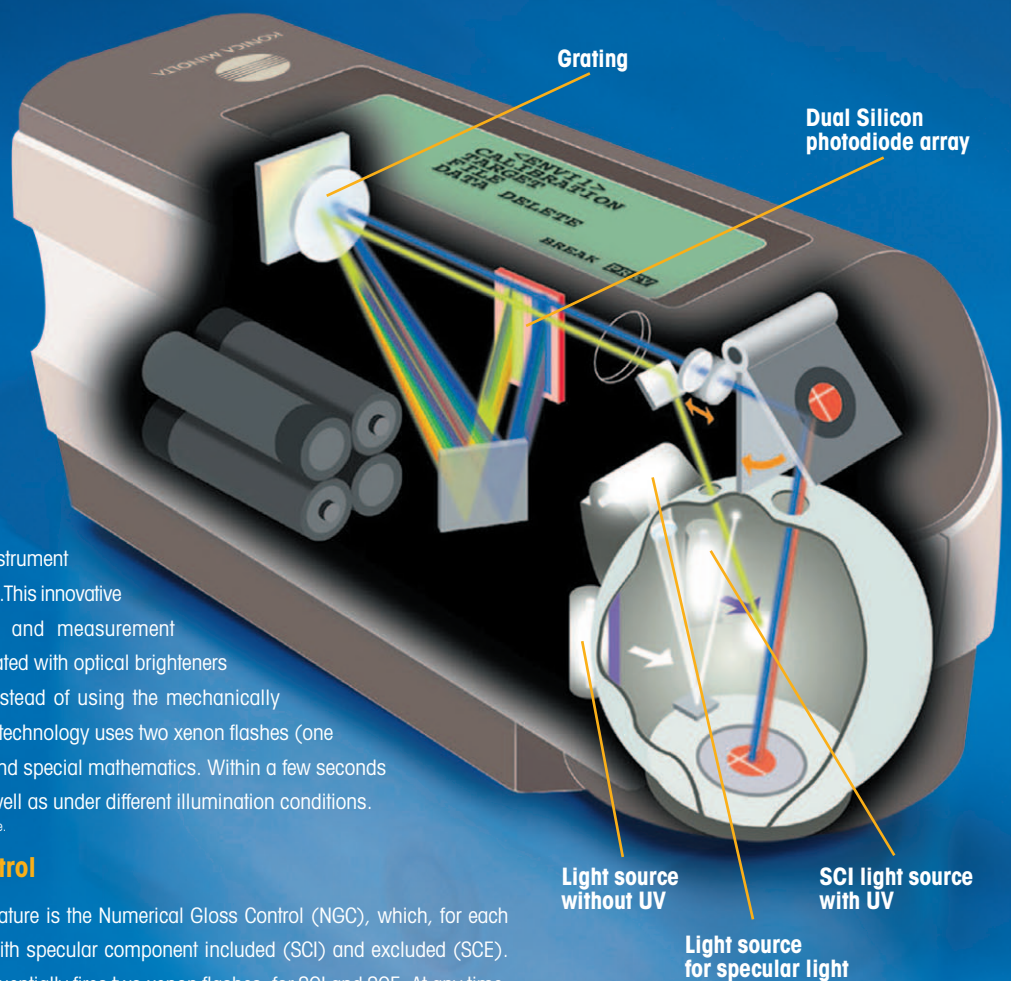

### On suitability in accordance with international Standards:

The optical construction has great importance on subjects like absolute accuracy, data compatibility with other (type, brand) instruments. They depend on the way the supplier designs and manufactures all optical parts such as the geometry, light dividing devices, monochromator.

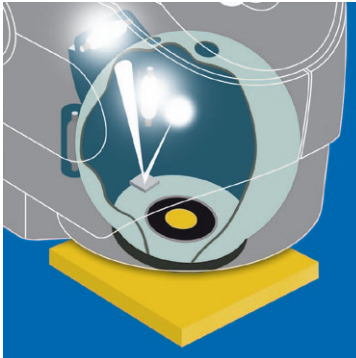

### On suitability for all kind of samples:

Samples you have to control come in all sorts of shapes, sizes and forms, which the instrument should be able to measure in an easy and repeatable way. Furthermore, time-consuming sample preparation prior to measurement should be avoided by the instrument's ability to measure it as it is.

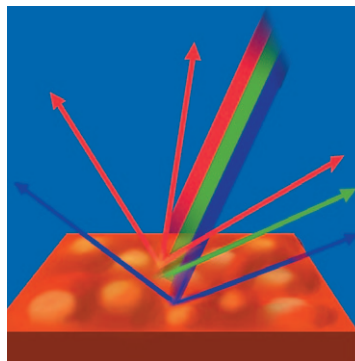

### On Color data information:

The way color data is output and presented is a vital factor in ensuring quick and easy routine quality control in production. A large easy to read display, fast assessment Pass/Fail indications, including understandable color descriptions in your language, as well as display of color and spectral graphs, makes the instrument understandable to all operators regardless of their color knowledge.

### On inter-instrument agreement:

Optimum performance is not a luxury, and you need to ensure you get reliable data throughout the instrument's lifetime. Many of your existing and future customers will undoubtedly have color measurement systems and will need to communicate with you about color data. Perfect inter-instrument agreement ensures data correlation between several instruments of the same type, whereas Inter-model agreement states the level of agreement between different types of instruments (e.g. portable and Bench-top instruments).

### On specular evaluation

Depending on the surface condition of the sample and the angle of observation, the eye can perceive different levels of specular gloss (high gloss, semi-gloss or matte). To evaluate the influence of the gloss on the color data, the  $d_i:8^\circ$ ,  $d_e:8^\circ$  geometry offers the ability to measure the sample including (SCI) or excluding (SCE) the specular component. Simultaneous assessment of SCI and SCE in one measurement offers great advantages in the speed and ease of use.

### On Design & Ergonomics:

The design, shape, weight and ease of operation dictates if the instrument is "suitable" for your application. Its ergonomics, how it fits into your hand, are vital to the daily working practices and integration into the work process.

### Today's standard requirements for portable color control:

- ✓ Optical system strictly in accordance with international standards (ISO, CIE, DIN, ASTM, AFNOR, JIS)
- ✓ Performances meeting your application for today and the future (repeatability, long term stability, inter-instrument agreement)
- ✓ Full and comprehensive color data information
- ✓ Compact, light, left or right handed operation
- ✓ Suitable for any shape or size of sample; Simultaneous SCI / SCE measurements

### 10 Additional features only the CM-2600d can offer you:

- Perfect sample observation with viewfinder
- Patented numerical Gloss control (NGC)
- Patented numerical UV calibration (standard equipment)
- Unique "Navigation wheel" for menu operation
- Intuitive operation flow
- Choice of six pre-selectable measurement modes
- Choice of three power supply modes (Batteries, rechargeable batteries, AC power)
- "Sleep mode" power saving system
- Yearly re-calibration reminder message

Specifications	
<b>Illumination/viewing system</b>	di:8°, de:8° (diffused illumination, 8-degree viewing angle), equipped with simultaneous measurement of SCI (specular component included)/SCE (specular component excluded). (Conforms to DIN 5033 Teil 1, JIS Z 8722 Condition C, ISO 7724/1, CIE No. 15, ASTM E1164.)
<b>Integrating sphere size</b>	∅ 52 mm
<b>Detector</b>	Silicon photodiode array (dual 40 elements)
<b>Spectral separation device</b>	Diffraction grating
<b>Wavelength range</b>	360 nm to 740 nm
<b>Wavelength pitch</b>	10 nm
<b>Half bandwidth</b>	Approx. 10 nm
<b>Reflectance range</b>	0 to 175%, Display resolution: 0.01%
<b>Light source</b>	3 pulsed xenon lamps (2 xenon lamps for CM-2500 d)
<b>Measurement time</b>	Approx. 1.5 seconds (approx. 2 seconds for fluorescent measurement)
<b>Minimum measurement interval</b>	3 seconds for SCI/SCE (4 seconds for fluorescent measurement) (Simultaneous evaluation of SCI/SCE is possible by a single measurement)
<b>Measurement/illumination area</b>	MAV: ∅ 8mm/∅ 11 mm SAV: ∅ 3 mm/∅ 6 mm (Selectable between MAV and SAV) (Only MAV is available for CM-2500d)
<b>Repeatability</b>	Standard deviation: Spectral Reflectance: within 0.1% (360 to 380nm within 0.2%) Chromaticity Value : Δ E*ab within 0.04 (When a white calibration plate is measured 30 times at 10-second intervals after white calibration)
<b>Inter-instrument agreement</b>	Δ E*ab within 0.2 (MAV/SCI) (Average for 12 BCRA Series II color tiles compared to values measured with master body)
<b>UV adjustment</b>	Instantaneous adjustment (no mechanical adjustment required) *With UV400nm cut filter (no UV adjustment function for CM-2500d)
<b>Measurement mode</b>	Single/overaging (auto mode: 3, 5, 8 flashes/manual mode)
<b>Interface</b>	Output:RS-232C serial signals via RJ45 connector; USB 2.0 communication possible when using included USB-Serial Converter Cable IF-A24
<b>Observer</b>	2° or 10° Standard Observer
<b>Illuminant</b>	A, C, D50, D65, F2, F6, F7, F8, F10, F11, F12 (simultaneous evaluation is possible using two light sources)
<b>Display data</b>	Spectral value/graph, colorimetric value, color difference value/graph, PASS / FAIL result,relativity gloss value
<b>Colorimetric data/indexes</b>	L*a*b*, L*C*h, CMC (1:1), CMC (2:1), CIE94, Hunter Lab,Yxy, Munsell, XYZ, MI, WI (ASTM E313-73), YI (ASTM E313-73/ASTM D1925), ISO Brightness (ISO 2470), Density status A/T, WI/Tint (CIE/Ganz), CIE00
<b>Data memory</b>	1700 pieces of data (as SCI/SCE 1 data) * 700 pieces of data in the *defined in COND.* mode. *Total of the sample data for the COND and TASK modes and color difference target data
<b>Pass/Fail judgment</b>	Tolerance for color difference (both box and elliptical tolerances can be set)
<b>Power</b>	AA-size batteries (x4) or AC Adapter
<b>Battery performance</b>	Approx. 1000 times at 10-second intervals (when alkaline batteries used)
<b>Size (WxHxD)</b>	69 x 96 x 193 mm
<b>Weight</b>	Approx. 670g (without batteries)
<b>Operation temperature/humidity range (*1)</b>	5 to 40 °C, relative humidity 80% or less (at 35°C) with no condensation
<b>Storage temperature/humidity range</b>	0 to 45 °C, relative humidity 80% or less (at 35°C) with no condensation
<b>Standard accessories</b>	White calibration plate, Target mask ∅ 8 mm, Target mask ∅ 3 mm (not supplied for CM-2500d), USB-Serial Converter Cable IF-A24, AC adapter, AA-size batteries (x4)
<b>Optional accessories</b>	Hard Case, Dust Cover Set, Dust Cover, SpectraMagic™ NX, Zero Calibration Box CM-A32, RS-232C Cable IF-A16

- \*1 Operation temperature/humidity range of products for North America : 5 to 40°C, relative humidity 80% or less (at 31°C) with no condensation
- The specifications and appearance shown herein are subject to change without notice.

### SAFETY PRECAUTIONS

For correct use and for your safety, be sure to read the instruction manual before using the instrument.



- Always connect the instrument to the specified power supply voltage. Improper connection may cause a fire or electric shock.
- Be sure to use the specified batteries. Using improper batteries may cause a fire or electric shock.



Certificate No : LRQ 0960094/A  
Registration Date : March 3, 1995



Certificate No : JQA-E-80027  
Registration Date : March 12, 1997

### System Diagram

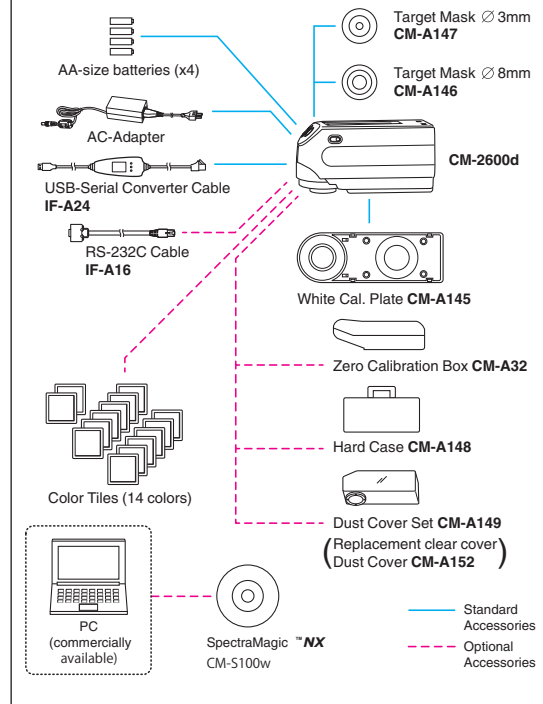

### Dimensions (Units:mm)

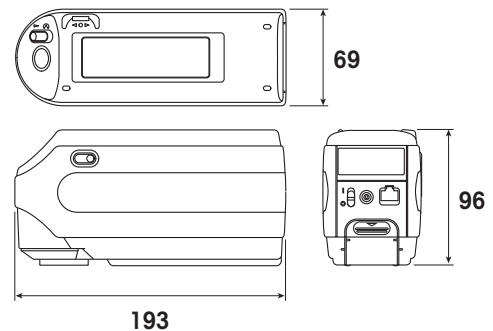

### CM-2500d the lower cost option

Same simplicity, same performance but with the following restrictions:

- No UV control
- Only ∅ 8 mm aperture

